



Owner's Manual

MJ413TG (13 INCH) MJ419TG (19 INCH) COLOR TELEVISION

FEATURES

- **181 Channel Selection-** All VHF/UHF channels plus up to 125 cable channels.
- **PLL Frequency Synthesized Tuning-** Provides free and easy channel selection and lets you tune directly to any channel using the channel number buttons on the remote control.
- **Sleep Timer**
- **Closed Caption Decoder**
- **Auto Shut Off Function-** If there is no signal input from the antenna terminal and no user operation for 15 minutes, the TV will turn itself off automatically.
- **V-CHIP-** Enables parents to prevent their children from watching inappropriate material on TV.
- **Tinted, Bright Black Matrix Picture Tube**
- **Full-Function Remote Control**
- **On-Screen Function Display**
- **Front AV Input**
- **Resume Function-** If the power fails or is disconnected while the TV is on, the TV will turn on automatically when the power resumes.

PRECAUTIONS

- Place your TV in a room with adequate ventilation.
- Keep your TV set away from sources of direct heat, such as heat registers or direct sunlight.
- Do not place your TV on soft surfaces, such as rugs or blankets.
- Leave enough room for air to circulate around the bottom, top and back of the set.

The serial number of this product may be found on the back of the TV. No others have the same serial number as yours. You should record the number and other vital information here and retain this book as a permanent record of your purchase to aid identification in case of theft.

Date of Purchase		Dealer Phone No.	
Dealer Purchase from		Model No.	
Dealer Address		Serial No.	

IMPORTANT SAFEGUARDS

WARNING:

TO REDUCE THE RISK OF FIRE OR ELECTRIC SHOCK, DO NOT EXPOSE THIS APPLIANCE TO RAIN OR MOISTURE.



CAUTION: TO REDUCE THE RISK OF ELECTRIC SHOCK, DO NOT REMOVE COVER (OR BACK) NO USER SERVICEABLE PARTS INSIDE. REFER SERVICING TO QUALIFIED SERVICE PERSONNEL.

The important note is located on the rear of the cabinet.

1. **READ INSTRUCTIONS** - All the safety and operating instructions should be read before the appliance is operated.
2. **RETAIN INSTRUCTIONS** - The safety and operating instructions should be retained for future reference.
3. **HEED WARNINGS** - All warnings on the appliance and in the operating instructions should be adhered to.
4. **FOLLOW INSTRUCTIONS** - All operating and use instructions should be followed.
5. **CLEANING** - Unplug TV from the wall outlet before cleaning. Do not use liquid cleaners or aerosol cleaners. Use a damp cloth for cleaning.
EXCEPTION: A product that is meant for uninterrupted service and, that for some specific reason, such as the possibility of the loss of an authorization code for a CATV converter, is not intended to be unplugged by the user for cleaning or any other purpose, may exclude the reference to unplugging the appliance in the cleaning description otherwise required in item 5.
6. **ATTACHMENTS** - Do not use attachments not recommended by the TV manufacturer as they may cause hazards.
7. **WATER AND MOISTURE** - Do not use this TV near water, for example, near a bath tub, wash bowl, kitchen sink, or laundry tub, in a wet basement, or near a swimming pool, and the like.
8. **ACCESSORIES** - Do not place this TV on an unstable cart, stand, tripod, bracket, or table. The TV may fall, causing serious injury to someone, and serious damage to the appliance. Use only with a cart, stand, tripod, bracket, or table recommended by the manufacturer, or sold with the TV. Any mounting of the appliance should follow the manufacturer's instructions and should use a mounting accessory recommended by the manufacturer. An appliance and cart combination should be moved with care. Quick stops, excessive force, and uneven surfaces may cause the appliance and cart combination to overturn.

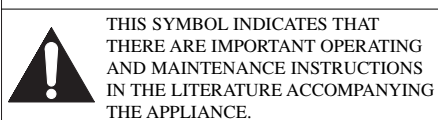
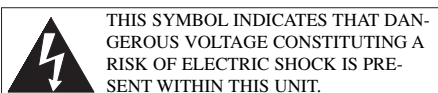

- AMEUBLES** - Cet appareil ne doit être placé que sur un meuble (avec ou sans roulettes) recommandé par le fabricant. Si vous l'installez sur un meuble à roulettes, déplacez les deux ensembles avec précaution. Un arrêt brusque, l'utilisation d'une force excessive et des surfaces irrégulières risquent de déstabiliser l'ensemble et de le renverser.
- 9. VENTILATION** - Slots and openings in the cabinet and the back or bottom are provided for ventilation and to ensure reliable operation of the TV and to protect it from overheating, these openings must not be blocked or covered. The openings should never be blocked by placing the TV on a bed, sofa, rug, or other similar surface. This TV should never be placed near or over a radiator or heat register. This TV should not be placed in a built-in installation such as a bookcase or rack unless proper ventilation is provided or the manufacturer's instructions have been adhered to.
- 10. POWER SOURCES** - This TV should be operated only from the type of power source indicated on the marking label. If you are not sure of the type of power supply to your home, consult your appliance dealer or local power company. For TVs intended to operate from battery power, or other sources, refer to the operating instructions.
- 11. GROUNDING OR POLARIZATION** - This TV is equipped with a polarized alternating-current line plug (a plug having one blade wider than the other). This plug will fit into the power outlet only one way. This is a safety feature. If you are unable to insert the plug fully into the outlet, try reversing the plug. If the plug should still fail to fit, contact your electrician to replace your obsolete outlet. Do not defeat the safety purpose of the polarized plug.
- 12. POWER-CORD PROTECTION** - Power-supply cords should be routed so that they are not likely to be walked on or pinched by items placed upon or against them, paying particular attention to cords at plugs, con-



gfm LIMITED WARRANTY PERIOD:

This Limited Warranty begins on the date of purchase of the Covered Product and continues for a period of six months.

WHAT IS COVERED:
Meijer will pay the cost of labor and repair or replacement parts in the event Your Covered Product fails to operate as a result of a mechanical or electrical failure caused by defects in workmanship and/or materials. A mechanical or electrical failure caused by a direct result of a power surge is also covered. Parts will be replaced with those of like kind and quality, and may be new or remanufactured. If the Covered Product cannot be repaired, if the cost of the repair exceeds the original purchase price or if parts are not available due to the age of the Covered Product or discontinued by the manufacturer, the Covered Product will be replaced with a product of similar features.

WHERE YOU ARE COVERED:
Coverage under this Limited Warranty is limited to the United States of America, including the District of Columbia. It does not include any Canadian or U.S. Territories including Guam, Puerto Rico, or U.S. Virgin Islands.

WHAT IS NOT COVERED:

- PRODUCTS NOT ORIGINALLY COVERED BY A MANUFACTURER'S WARRANTY;
- ITEMS THAT ARE STILL COVERED BY THE MANUFACTURER'S WARRANTY, REGARDLESS OF WHETHER THE MANUFACTURER HONORS SUCH WARRANTY;
- PERIODIC CHECKUPS AND/OR PREVENTIVE MAINTENANCE AS DIRECTED BY THE MANUFACTURER EXCEPT AS PROVIDED HEREIN;
- INHERENT PRODUCT DEFECTS THAT ARE THE RESPONSIBILITY OF THE MANUFACTURER OR PARTS FAILURE DUE TO A MANUFACTURER'S RECALL;
- ANY AND ALL PRE-EXISTING CONDITIONS THAT OCCUR PRIOR TO THE EFFECTIVE DATE OF THIS LIMITED WARRANTY AND/OR ANY COSTS TO REPAIR ANY PRODUCT SOLD "AS-IS" INCLUDING BUT NOT LIMITED TO FLOOR MODELS, DEMONSTRATION MODELS, ETC.
- PARTS OR REPAIRS DUE TO NORMAL WEAR AND TEAR AND ITEMS NORMALLY DESIGNED TO BE PERIODICALLY REPLACED BY THE PURCHASER DURING THE COVERED PRODUCT'S LIFE, INCLUDING BUT NOT LIMITED TO BATTERIES, LIGHT BULBS, ETC.;
- DAMAGE FROM ACCIDENT, ABUSE, MISUSE, MISHANDLING, INTRODUCTION OF FOREIGN OBJECTS INTO THE COVERED PRODUCT, UNAUTHORIZED MODIFICATIONS OR ALTERATIONS TO A COVERED PRODUCT, FAILURE TO FOLLOW THE MANUFACTURER'S INSTRUCTIONS, AND EXTERNAL CAUSES INCLUDING THIRD PARTY ACTIONS, FIRE, THEFT, INSECTS, ANIMALS, EXPOSURE TO WEATHER CONDITIONS, WINDSTORM, SAND, DIRT, HAIL, EARTHQUAKE, FLOOD, WATER, ACTS OF GOD OR CONSEQUENTIAL LOSS OF ANY NATURE;
- LOSS OR DAMAGE CAUSED BY WAR, INVASION OR ACT OF FOREIGN ENEMY, HOSTILITIES, CIVIL WAR, REBELLION, RIOT, STRIKE, LABOR DISTURBANCE, LOCKOUT, OR CIVIL COMMOTION;
- INCIDENTAL, CONSEQUENTIAL OR SECONDARY DAMAGES OR DELAY IN RENDERING SERVICE UNDER THIS LIMITED WARRANTY, OR LOSS OF USE DURING THE PERIOD THAT THE COVERED PRODUCT IS AT AN AUTHORIZED SERVICE CENTER OR OTHERWISE AWAITING PARTS;
- ANY PRODUCT USED IN A COMMERCIAL SETTING OR RENTAL BASIS;
- FAILURES THAT OCCUR OUTSIDE OF THE 50 STATES OF THE UNITED STATES OF AMERICA, INCLUDING THE DISTRICT OF COLUMBIA;
- NONFUNCTIONAL OR AESTHETIC PARTS INCLUDING BUT NOT LIMITED TO PLASTIC PARTS, KNOBS, ROLLERS, BASKETS, SCRATCHES, PEELING AND DENTS;
- UNAUTHORIZED REPAIRS AND/OR PARTS;
- COST OF INSTALLATION, SET-UP, DIAGNOSTIC CHARGES, REMOVAL OR REINSTALLATION OF THE COVERED PRODUCT, EXCEPT AS PROVIDED HEREIN;
- ACCESSORIES USED IN CONJUNCTION WITH A COVERED PRODUCT;
- ANY LOSS OTHER THAN A COVERED BREAKDOWN OF THE COVERED PRODUCT;
- SERVICE WHERE NO PROBLEM CAN BE FOUND;
- BREAKDOWNS WHICH ARE NOT REPORTED WITHIN THE TERM OF THIS LIMITED WARRANTY;
- IMPROPER INSTALLATION OF COMPONENTS OR PERIPHERALS;
- CORRUPTION OF ANY RECORDING MEDIA, INCLUDING ANY PROGRAM, DATA OR SETUP INFORMATION RESIDENT ON ANY HARD DRIVES AND INTERNAL OR EXTERNAL REMOVABLE STORAGE DEVICES, AS A RESULT OF THE MALFUNCTIONING OR DAMAGE OF AN OPERATING PART, OR AS A RESULT OF ANY REPAIRS OR REPLACEMENT UNDER THIS LIMITED WARRANTY;
- DAMAGE TO CLOTHING;
- COLOR FADING OF PICTURE FOR ANY TELEVISION;
- BURNED-IN PHOSPHOR (INCLUDING IMAGE GHOSTING), PIXEL BURNOUT NOT IN ACCORDANCE WITH THE MANUFACTURER'S SPECIFICATIONS.

WHAT TO DO WHEN YOUR PRODUCT FAILS TO OPERATE:

- Call the 24-hour customer service toll-free number at (866) 845-9436.

Many oversights, which are not covered under this Limited Warranty, can be due to simple circumstances such as the Covered Product not being switched on, being unplugged, or a fuse blown at the junction box. For a Covered Product that uses batteries as the primary power supply, or a remote control unit, please check that the batteries do not need replacing or recharging.

SERVICE DELIVERABLES:
There is no deductible required to obtain service for Your Covered Product.

OTHER PROVISIONS:

Limit of Liability:
The limit of liability under this Limited Warranty is the least of the cost of (1) the purchase price of the Covered Product excluding tax and delivery costs or (2) authorized repairs not to exceed the purchase price of the Covered Product or (3) replacement of the Covered Product with similar features or (4) reimbursement for authorized repairs or replacement. Upon replacement, there is no longer any obligation for the replaced product under this Limited Warranty.

Limitations of Implied Warranty:
All Implied Warranties which may arise under state law, including all Implied Warranties of Merchantability or Fitness for a particular purpose, are limited to the duration of this Warranty and do not cover incidental or consequential damages. Some states do not allow limitations on how long an Implied Warranty lasts or the exclusion of incidental or consequential damages, so the above limitations or exclusions may not apply to You. This Warranty gives You specific legal rights, and You may also have other rights which vary from state to state.

Transferability and Renewals:
This Limited Warranty is not transferable or renewable.

Subrogation:
If We pay for a loss, We may require You to assign Us Your rights of recovery against others. We will not pay for a loss if You impair these rights to recover. Your rights to recover from others may not be waived.

Arbitration:
In the event of a disagreement between You and Us concerning costs, either of us may make a written demand for arbitration. This must be done within sixty (60) days after the day You filed Your claim. Each of us will select an arbitrator. The two arbitrators will select an umpire. Each of us will pay the expenses of the arbitrator We select. The expenses of the umpire will be shared equally. Unless both of us agree otherwise, arbitration will take place in the county and state in which You live. Local rules apply. A majority decision will be binding.

IEMN21787

Printed in Malaysia
L2209WK / L2309WK * * * * *

- venience receptacles, and the point where they exit from the appliance.
13. **OUTDOOR ANTENNA GROUNDING** - If an outside antenna or cable system is connected to the TV, be sure the antenna or cable system is grounded so as to provide some protection against voltage surges and built-up static charges. Article 810 of the National Electrical Code, ANSI/NFPA No. 70, provides information with respect to proper grounding of the mast and supporting structure, grounding of the lead-in wire to an antenna discharge unit, size of grounding conductors, location of antenna-discharge unit, connection to grounding electrodes, and requirements for the grounding electrode. (Fig. A)
 14. **LIGHTNING** - For added protection for this TV receiver during a lightning storm, or when it is left unattended and unused for long periods of time, unplug it from the wall outlet and disconnect the antenna or cable system. This will prevent damage to the TV due to lightning and power-line surges.
 15. **POWER LINES** - An outside antenna system should not be located in the vicinity of overhead power lines or other electric light of power circuits, or where it can fall into such power lines or circuits. When installing an outside antenna system, extreme care should be taken to keep from touching such power lines or circuits as contact with them might be fatal.
 16. **OVERLOADING** - Do not overload wall outlets and extension cords as this can result in a risk of fire or electric shock.
 17. **OBJECT AND LIQUID ENTRY** - Never push objects of any kind into this TV through openings as they may touch dangerous voltage points or short out parts that could result in a fire or electric shock. Never spill liquid of any kind on the TV.
 18. **SERVICING** - Do not attempt to service this TV yourself as opening or removing covers may expose you to dangerous voltage or other hazards. Refer all servicing to qualified service personnel.
 19. **DAMAGE REQUIRING SERVICE** - Unplug this TV from the wall outlet and refer servicing to qualified service personnel under the following conditions:
 - a. When the power supply cord or plug is damaged or frayed.
 - b. If liquid has been spilled, or objects have fallen into the TV.
 - c. If the TV has been exposed to rain or water.
 - d. If the TV does not operate normally by following the operating instructions. Adjust only those controls that are covered by the operating instructions, as improper adjustment of other controls may result in damage and will often require extensive work by a qualified technician to restore the TV to its normal operation.
 - e. If the TV has been dropped or damaged in any way.
 - f. When the TV exhibits a distinct change in performance, this indicates a need for service.
 20. **REPLACEMENT PARTS** - When replacement parts are required, be sure the service technician uses replacement parts specified by the manufacturer that have the same characteristics as the original part. Unauthorized substitutions may result in fire, electric shock, injury to persons or other hazards.
 21. **SAFETY CHECK** - Upon completion of any service or repairs to this TV, ask the service technician to perform routine safety checks to determine that the TV is in proper operating condition.
 22. **HEAT** - This TV product should be situated away from heat sources such as radiators, heat registers, stoves, or other products (including amplifiers) that produce heat.

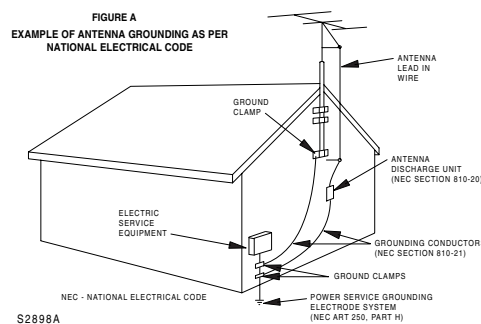

FCC WARNING - This equipment may generate or use radio frequency energy. Changes or modifications to this equipment may cause harmful interference unless the modifications are expressly approved in the instruction manual. The user could lose the authority to operate this equipment if an unauthorized change or modification is made.

Note to CATV system installer:
This reminder is provided to call the CATV system installer's attention to Article 820-40 of the NEC that provides guidelines for proper grounding and, in particular, specifies that the cable ground shall be connected to the grounding system of the building as close to the point of cable entry as practical.

PREPARATION FOR USE

CONNECTIONS

Plug the incoming cable into the ANT. IN jack on the rear of the TV.

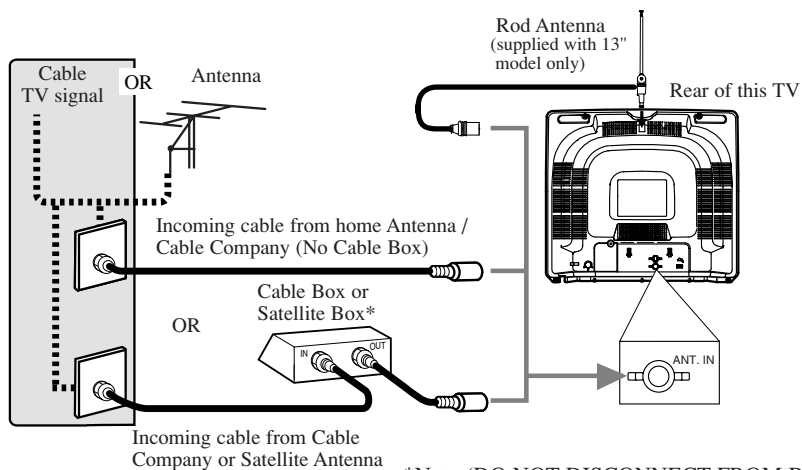

*Cables not included

***Note (DO NOT DISCONNECT FROM BOX)**
Some cable TV systems use scrambled signals and require a special converter to receive these channels. Consult your local cable company.

CAUTION: TO PREVENT ELECTRIC SHOCK, MATCH WIDE BLADE OF PLUG TO WIDE SLOT, FULLY INSERT.

ATTENTION: POUR ÉVITER LES CHOC ÉLECTRIQUES, INTRODUIRE LA LAME LA PLUS LARGE DE LA FICHE DANS LA BORNE CORRESPONDANTE DE LA PRISE ET POUSSER JUSQU'AU FOND.

Note:

- For your safety and to avoid damages to the unit, unplug the antenna cable from the ANT. IN jack before moving the unit.

[EXTERNAL CONNECTION]

Front AUDIO/VIDEO input

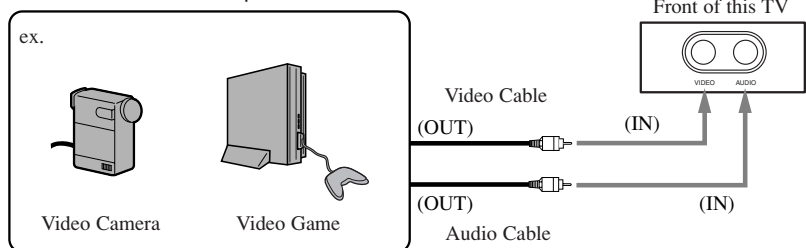

SELECTING AUDIO/VIDEO INPUT

You can select external input jacks by pressing **[GAME]** on the remote control.

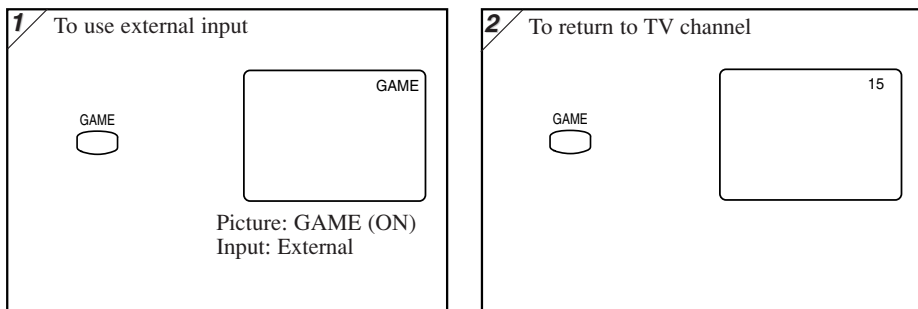

In the Game mode, you can use front input jacks with suitable picture adjustments for video games.

Notes:

- If you press **[GAME]** when the TV is off, the TV turns on and enters in Game mode.
- If you adjust another picture control while in Game mode, this mode will automatically be canceled.

You can enter into Video mode from Game mode by adjusting a Picture control.

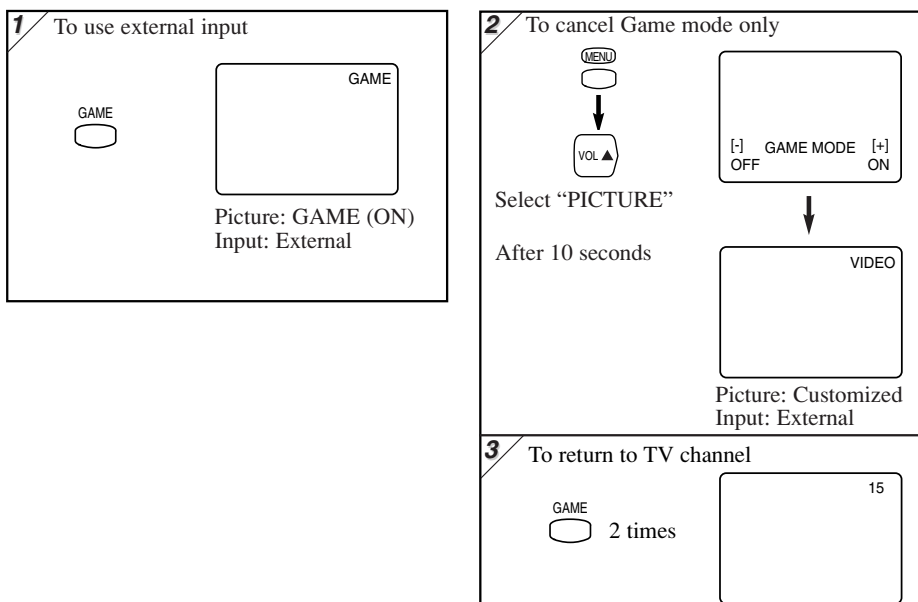

INSTALLING THE BATTERIES

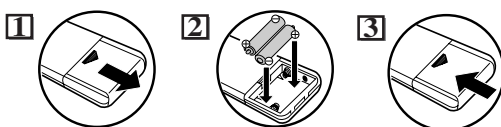

Install two AA batteries (supplied) matching the polarity indicated inside battery compartment of the remote control.

[BATTERY PRECAUTIONS]

- Be sure to follow the correct polarity as indicated in the battery compartment. Reversed batteries may cause damage to the device.
- Do not mix different types of batteries together (e.g. Alkaline and Carbon-Zinc) or old batteries with fresh ones.
- If the device is not to be used for a long period of time, remove the batteries to prevent damage or injury from possible battery leakage.
- Do not try to recharge batteries not intended to be recharged; they can overheat and rupture.

OPERATIONS

REMOTE CONTROL AND FRONT PANEL FUNCTION

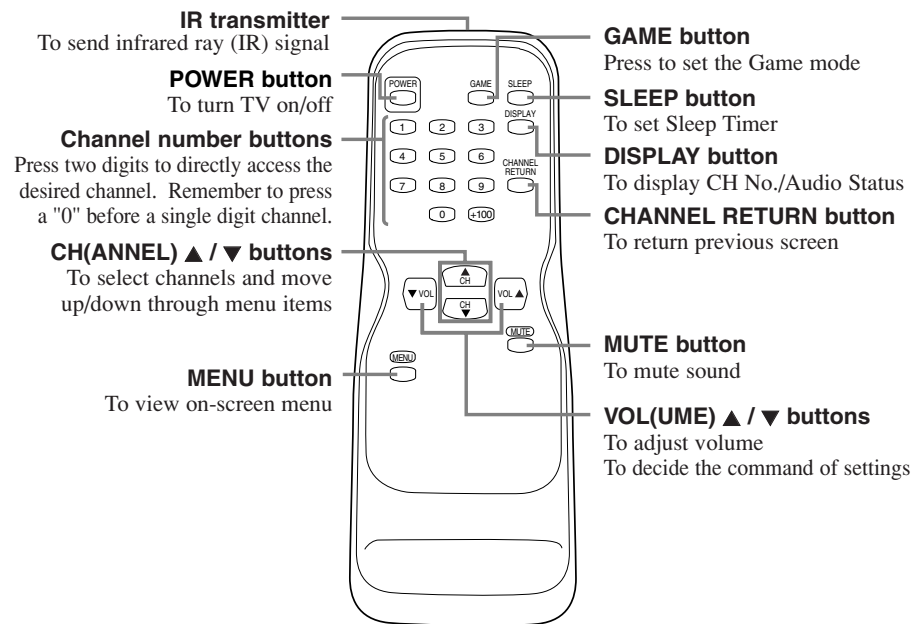

Note:

- You can test if the remote control sends out the infrared signal with an AM radio. (Refer to "TROUBLESHOOTING GUIDE".)

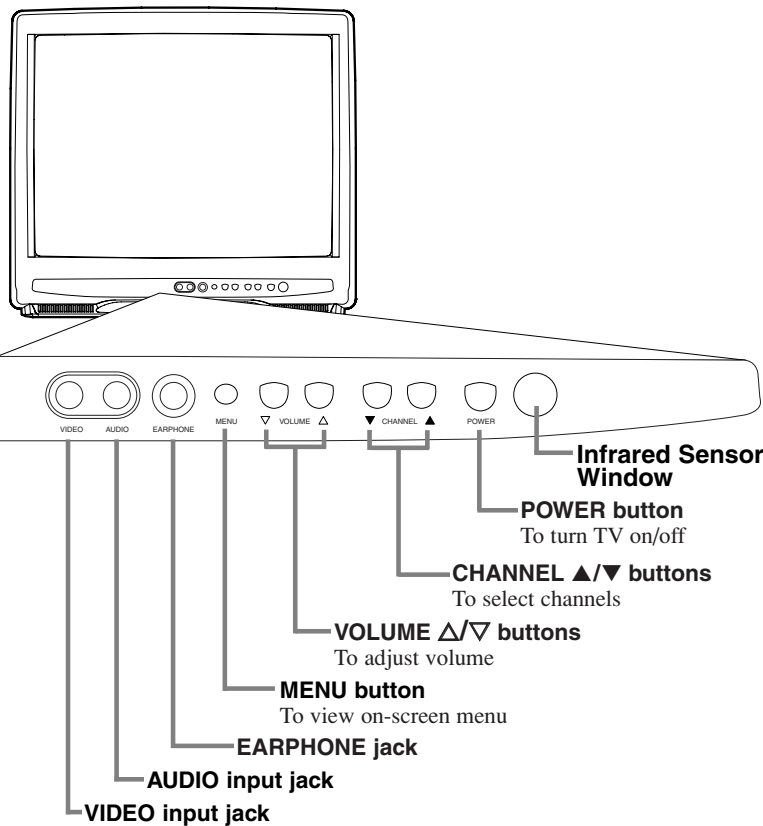

Note:

- If some digits appear in the corner of the screen when the unit is turned on for the first time, press **[POWER]** without unplugging the power cord.

This manual covers 13" and 19". The operation of the two models are exactly the same except the appearance. 19" model is illustrated in this manual.

OPERATIONS (Continued)

CHANNEL SETTING

[AUTO PRESET CHANNELS]

As the initial setting, this TV has memorized all channels, including the ones not available in your area. This feature automatically puts only available channels into the memory.

1 Select "CHANNEL SET"

2 Select "AUTO PRESET CH"

The tuner scans and memorizes all available channels in your area.

3 When the scanning is completed, the lowest memorized channel appears on the TV screen.

Notes:

- The TV distinguishes between standard TV channels and cable (CATV) channels.
- The TV may recognize TV channels as CATV channels if reception condition is poor. If this happens, check the antenna connections and try steps **2** to **3** again when reception conditions are better.
- If there is no TV signal input, "NO TV SIGNALS" will appear on the display after the completion of channel scanning.

[ADDING/DELETING CHANNELS]

You can add or delete channels manually.

1 Select "CHANNEL SET"

2 Select "ADD/DELETE"

3 Select the channel you wish

4 Add or delete the channel

Add: light blue
Delete: light red

Note:

- The menu will disappear automatically after about 10 seconds.

CLOSED CAPTION

You may view specially labeled (cc) TV programs, movies, news and prerecorded tapes, etc. with either a dialogue caption or text display added to the program.

1 Select "CAPTION"

[CAPTION MODE (C1, C2)]

- CAPTION1 (C1)**
displays standard closed captions (what a character is saying).
- CAPTION2 (C2)**
displays foreign language closed captions (foreign language words showing what a character is saying).
- There are three ways of displaying according to programs:
Paint-on mode: Displays input characters on the screen immediately.
Pop-on mode : Once characters are stored in memory, they are displayed all at once.
Roll-up mode : Displays the characters continuously by scrolling (max. 4 lines).

[TEXT MODE (T1, T2)]

- TEXT1 (T1)** and **TEXT2 (T2)** display half-screen text by scrolling (such as a channel guide, schedule or announcement).
-

2 Select the desired caption mode

3 To exit the menu

Notes:

- If closed captioning is not broadcasted, you cannot receive it and nothing is displayed.
- When your TV receives a special effects playback signal (i.e., Search, Slow and Still) from a VCR's video output channel (CH3 or CH4), the TV may not display the correct caption or text.
- Captions and texts may not match the TV voice exactly.
- Interference may cause the closed caption system not to function properly.
- The caption or text characters will not be displayed while the menu display or functions display is shown.
- If a black box appears on the screen, this means that the TV is set to TEXT mode. To clear screen, select CAPTION [C1], [C2] or [OFF].

SLEEP TIMER SETTING

1

2

The time increases by 10 minutes up to 90.

- Notes:**
- When you disconnect the unit from the AC outlet or when you have a power failure, the sleep time will be lost.
 - To cancel the sleep timer, press [SLEEP] repeatedly until "SLEEP 0" is displayed.
 - The Sleep Timer Setting display will disappear automatically after 10 seconds of the operation.

OPTIONAL SETTINGS

LANGUAGE SELECTION

1 Select [ENG]

2 Select the desired language

3 To exit the menu

PICTURE ADJUSTMENT

1 Select "PICTURE"

2 Select an item to adjust

3 Adjust the setting

GAME MODE

Set to the most suitable position for video games.

[-] : OFF [+] : ON

BRIGHT

Adjust until the darkest parts of the picture are as bright as you prefer.

[-] : decrease brightness

[+] : increase brightness

CONTRAST

Adjust to increase or decrease contrast.

[-] : decrease contrast

[+] : increase contrast

COLOR

Adjust to be brilliant or pale color.

[-] : be pale color [+] : be brilliant color

TINT

Adjust to obtain natural skin tones.

[-] : add red [+] : add green

- Notes:**
- The display will disappear automatically after 10 seconds unless you press any buttons.
 - Magnetism from nearby appliances and speakers might affect the color of the TV picture. If this happens, press [POWER] to turn off the TV and turn it on again after about 30 minutes.

OPTIONAL SETTINGS (Continued)

V-CHIP SET UP

This enables parents to prevent their children from watching inappropriate material on TV.

- The limitation is not available for news, sports programs, unedited movies on premium cable channels and Emergency Broadcast System signals.
- When you try to access to a program which is blocked, "PROTECTED PROGRAM by ..." message appears on the TV screen.
- Programming may be rated by the Motion Picture Association of America (MPAA) or according to the Television Parental Guidelines. In order to block any inappropriate programming, set your limits in both MPAA RATING and TV RATING.

[TV RATING SET UP]

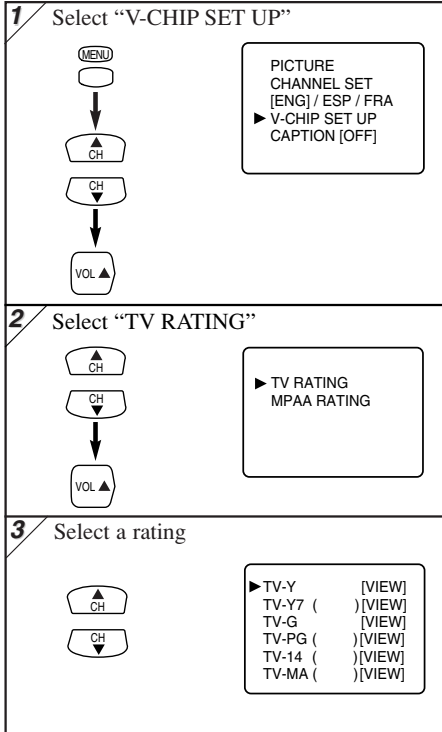

<Selection>	<Rating Category Explanations>
• TV-Y :	Appropriate for all children
• TV-Y7 :	Appropriate for children seven and older
• TV-G :	General Audience
• TV-PG :	Parental Guidance suggested
• TV-14 :	Unsuitable for children under 14
• TV-MA :	Mature audience only

4-1 * Rating with no sub categories
Set to [BLOCK] or [VIEW]

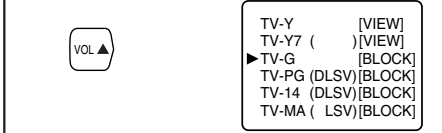

4-2 * Rating with sub categories

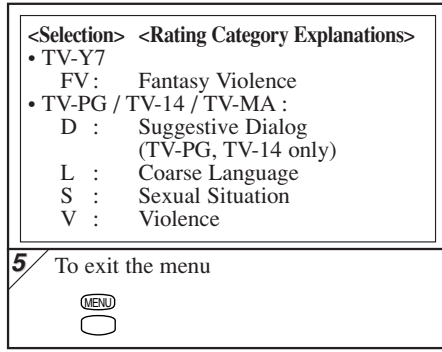
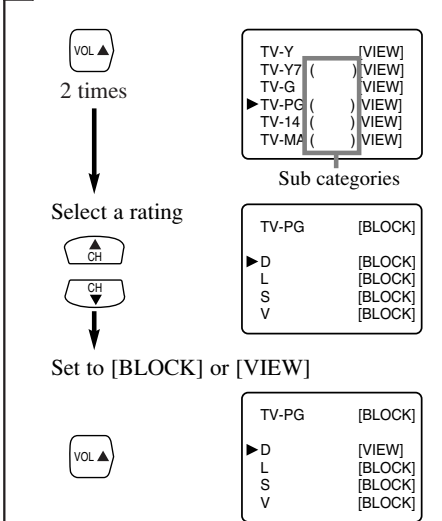

[MPAA RATING SET UP]

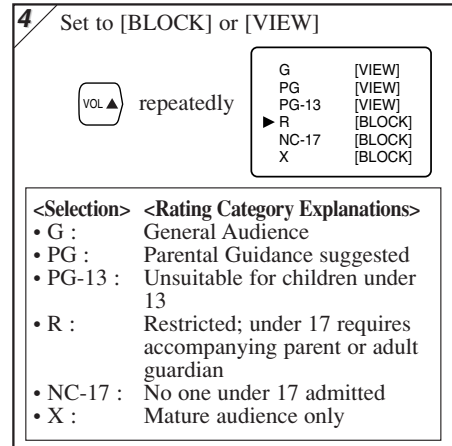
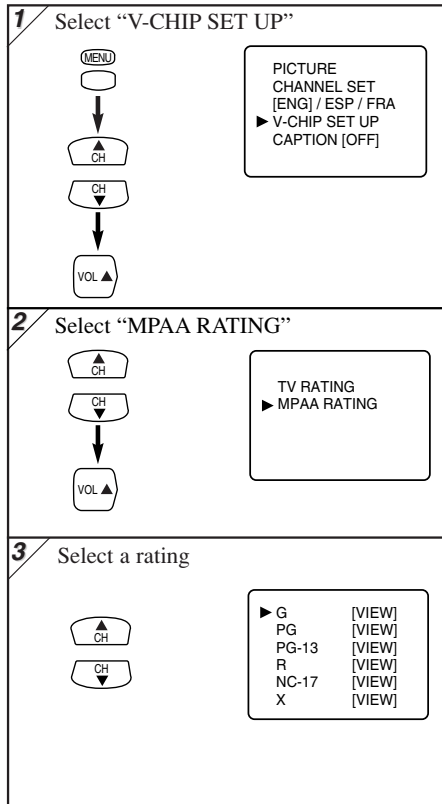

Notes (for TV RATING and MPAA RATING):

- You cannot access the setup menu when the "PROTECTED PROGRAM by ..." message appears. Move to an unblocked channel before you press [MENU].
- When you select a rating and set it to [BLOCK], the higher ratings will be blocked automatically. The lower ratings will be available for viewing.
- When you set the lowest rating to [VIEW], all other ratings will automatically be available for viewing.

TROUBLESHOOTING GUIDE

Sometimes a performance problem can be easily solved by checking seemingly apparent but often overlooked possibilities. Before arranging for service, check these items. It could save your time and money.

QUICK SERVICE CHECK LIST	PROBLEM													
	Remote Control Doesn't Work	Bars On Screen	Picture Distorted	Picture Rolls Vertically	No Color	Poor Reception on Some Channels	Weak Picture	Lines or Streaks in Picture	Ghosts in picture	Picture Blurred	Sound OK, Picture Poor	Picture OK, Sound Poor	No Picture or Sound	Different color marks on screen
Try a new channel, if OK, then possible station trouble.			X	X	X	X	X	X	X	X	X	X	X	X
Is TV plugged in? Power at outlet?	X													X
Is TV's power on?														X
Is antenna or cable connected to terminal on the back of the set?					X	X	X	X	X	X	X	X	X	
If outside antenna is being used, check for broken wire or loose connection.	X	X	X	X	X	X	X	X	X	X	X	X	X	
Check for local interference.	X	X	X	X	X	X	X	X	X	X	X	X	X	
Turn off the TV and then turn it on after about a minute.														X
Adjust COLOR control.					X									
Adjust CONTRAST & BRIGHT control.						X				X				
Check batteries in remote control.	X													
Move the TV away from the nearby appliances which generate a magnetic field. Turn off using [POWER], then turn it on again 30 minutes later or so.														X
Check if there is an obstacle between the sensor and the remote control.	X													
Test the signal output.* If OK, then possible remote sensor trouble.	X													

*Additional Remote Test
Tune an AM radio to a band with no broadcasting. Press a button on the remote control toward the radio. Sound will be fluttering when you press any key and the radio receives the signal. This means the remote control unit is working.

Closed Caption Problem	Possible Remedy
Misspelled captions are shown.	Spelling errors may pass through uncorrected by the closed captioning production company in a live broadcast.
Text is not shown in its entirety or there is a delay of what is being said.	Captions that are delayed a few seconds behind the actual dialogue are common for live broadcasts. Most captioning production companies can display a dialogue to a maximum of 220 words per minute. If a dialogue exceeds that rate, selective editing is used to insure that the captions remain up-to-date with the current TV screen dialogue.
Captions are scrambled with white boxes on the TV screen.	Interference caused by building, power lines, thunderstorms, etc. may cause scrambled or incomplete captions to appear.
No captions are displayed in a program which must contain closed caption.	Broadcasters may a time compression process to the actual program so that additional advertising time can be given. In this case, captions will be lost since the decoder cannot read the compressed information.
No captions are displayed when playing a prerecorded videotape with closed caption.	The videotape may be either an illegal copy or the tape duplicating company may accidentally have left out the captioning signals during the copying process.
The TV screen shows a black box.	You are in TEXT mode. Select CAPTION [C1], [C2] or [OFF].

MAINTENANCE

CABINET CLEANING

- Wipe the front panel and other exterior surfaces of the TV with a soft cloth immersed in lukewarm water and wrung dry.
- Never use a solvent or alcohol. Do not spray insecticide liquid near the TV. Such chemicals may cause damage and discoloration to the exposed surfaces.

PICTURE TUBE CLEANING

Wipe the picture tube of the TV with a soft cloth. Before cleaning the picture tube, disconnect the power cord.

SUPPLIED ACCESSORIES

- Owner's Manual (1EMN21787)
- Remote control unit (NE121UE)
- Batteries ("AA" x 2)
- Rod Antenna [13" model only supplied] (0EMN01755)

SPECIFICATIONS

GENERAL SPECIFICATIONS

Television system:	NTSC-M TV Standard
Closed Caption System:	§15.119/FCC
Channel coverage	VHF: 2 - 13 UHF: 14 - 69 CATV: 2 - 13, A - W, W+1 - W+84, A-5 - A-1, 5A
Tuning System:	181 channel frequency synthesized tuning system
Channel access:	Direct access keyboard, programmable scan and up/down
Terminals	
Antenna input:	VHF/UHF/CATV 75 ohm unbalanced (F-type)
Video input:	RCA connector x 1 (1 x Front)
Audio input:	RCA connector x 1 (1 x Front)
Earphone:	1/8" monaural (3.5mm)
1 speaker	

ELECTRICAL SPECIFICATIONS

Sound output: 1W, 8 ohm x 1

OTHER SPECIFICATIONS

Remote control:	Digital encoded infrared light system
Operating temperature:	5°C to 40°C (41°F - 104°F)
Power requirements:	AC120V, 60Hz
[13" model]	
Power consumption (Maximum):	53W
Picture tube:	13"
Dimensions:	H: 12-3/4"(323mm) W: 14-1/8"(358mm) D: 14-9/16"(370mm)
Weight:	18.7 lbs. (8.5kg)
[19" model]	
Power consumption (Maximum):	72W
Picture tube:	19"
Dimensions:	H: 16-3/4"(428mm) W: 18-3/4"(475mm) D: 18" (454mm)
Weight:	37.5 lbs. (17kg)

• Designs and specifications are subject to change without notice and without our legal obligation.
• If there is a discrepancy between languages, the default language will be English.